

ENERGY-EFFICIENT LIGHTWEIGHT TECHNOLOGIES

Marine Solutions

The shipping industry is facing more complex challenges than ever. Stricter environmental regulations to cut down greenhouse gas emissions and rising costs affect shipbuilding and operators. As a solution provider, we can help you to reduce energy costs. Our thermal and acoustic insulation systems and sustainable foam cores for composite structures increase energy efficiency and crew and passengers' safety and comfort. Don't miss the boat.

www.armacell.com



TOWARDS
GREENER
SHIPPING

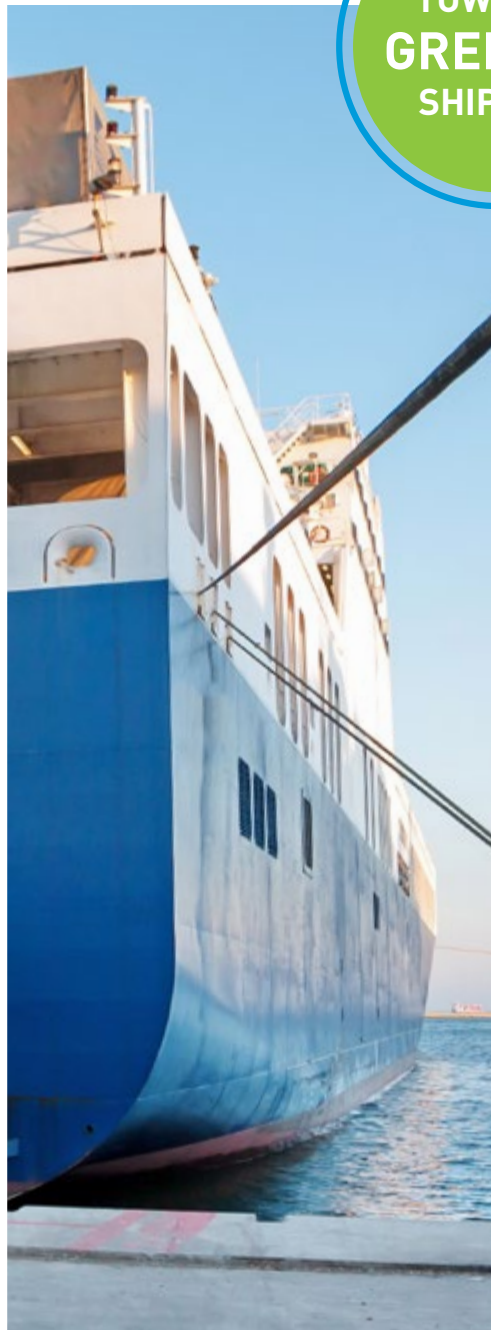

 **armacell**[®]
MAKING A DIFFERENCE AROUND THE WORLD

ABOUT ARMACELL

SOLUTIONS ENABLING ENERGY SAVINGS

We are the inventors of flexible foams for equipment insulation and a leading provider of engineered foams. Our lightweight thermal, acoustic and mechanical solutions create sustainable value for our customers. Innovation and entrepreneurship are an integral part of our DNA. We drive industry-leading solutions and aspire to launch new technologies using alternative resources or natural feedstock.

Our products significantly contribute to global energy efficiency and make a difference around the world. Addressing megatrends such as urbanisation, lightweighting and energy efficiency, our product solutions stand out in terms of functionality and ease of installation.

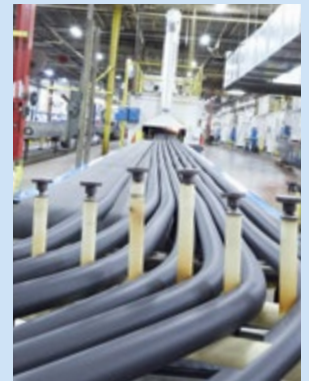

We create genuine value for our customers, value them as partners and are committed to developing solutions tailored to their requirements. The outcome is added value for our business partners and, most significantly, energy savings and a longer working life for their critical equipment.

Armacell. Making a difference around the world.

MARINE SOLUTIONS

NAVIGATING TOWARDS GREENER SHIPPING



ENERGY
EFFICIENCY



CONDENSATION
CONTROL



INDOOR
AIR QUALITY



FIRE
SAFETY



ACOUSTIC
COMFORT



LIGHTWEIGHT
MATERIALS



LONG-TERM
SAFE OPERATION

While maritime transport is one of the most energy-efficient modes of transport, it is also a large and growing contributor to greenhouse gas emissions. Accounting for 3 to 4 percent of Europe's CO₂ emissions, technological innovation and supportive policies are needed to steer the shipping sector onto the path of net-zero emissions by 2050.

Insulating mechanical equipment is one of the simplest and most efficient measures to save energy on board. Our insulation solutions reduce energy costs for operators and tackle climate change by preventing CO₂ emissions. They ensure rapid amortisation and minimise the risk of downtime due to unplanned maintenance work.

The lighter the ship, the more energy efficient and cost effective its operation. Their unique material and processing properties make our ArmaPET materials the ideal core solution for structural and interior elements on board.

With the primary objective of insulation – performance and energy efficiency – remain the same, different insulation materials may need to be considered for the various types of vessels and their requirements. Condensation control, mitigation of corrosion under insulation (CUI), mechanical protection, air quality, noise abatement, and fire safety are key requirements which can only be fulfilled with innovative insulation solutions.



WE UNDERSTAND THE CHALLENGES IN TODAY'S SHIPBUILDING INDUSTRY AND ARE COMMITTED TO CREATING AN EXCEPTIONAL CUSTOMER EXPERIENCE. **MAKE ARMACELL YOUR FIRST PORT OF CALL FOR EQUIPMENT INSULATION.**

CONTENT

- 02 About Armacell
- 04 Cruise ships
- 08 Ferries
- 12 Yachts
- 16 Sport boats
- 20 Fishing vessels
- 24 Cargo ships
- 28 Track record
- 29 Product selector

TECHNICAL INSULATION

ENERGY EFFICIENCY FOR CRUISE SHIPS

Cruise ships are basically floating small towns and they have similar energy needs. To ensure a pleasant room temperature on board, the air-conditioning systems work tirelessly. They also dehumidify and desalinate the damp sea air. Accounting for 30 to 40 percent of energy consumption, air conditioning and refrigeration account for the second largest share after propulsion.

Technical equipment has to be protected against energy losses and condensation. Damp insulation is as unhelpful as a wet woollen coat in winter and does not protect the equipment against either energy losses or corrosion. The high humidity and the risk of moisture penetrating the insulation increase the risk of

condensation and corrosion at sea. Only closed-cell insulation materials effectively prevent moisture from penetrating the insulation material, controlling condensation and mitigating the risk of corrosion under insulation. Our flexible elastomeric foams have a completely closed-cell material structure and a high

resistance to water vapour transmission. They provide technical equipment with reliable long-term protection against condensation and energy losses. They can significantly increase energy efficiency and thus reduce operating costs on ships. We offer system solutions which greatly reduce the risk of failing the inspection.

ArmaFlex Ultima®



The new safety standard in technical insulation: ArmaFlex Ultima exhibits 10 times less smoke in a fire than a standard elastomeric foam, thus extending the time to evacuate in the event of a fire.

ArmaFlex Protect®



Reliable firestop solution for sealing off pipe penetrations in A-class divisions and B-class bulkheads; tested according to IMO 2010 FTP Code Part 3, IMO-Resolution MSC.307(88).

ArmaClad™ Arma-Chek Juna

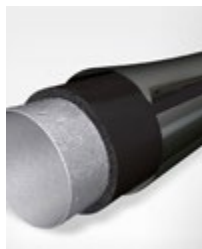

Our flexible 2-in-1 system protects equipment and insulation from damage. It can be used on combustible and non-combustible equipment such as flexible beverage lines.

ArmaGel®



Aerogel-based insulation with superior thermal and acoustic insulation properties for temperatures down to -180 °C.

ArmaComfort® Reflamex



With 31 percent of passengers finding cruise ship cabins to be acoustically uncomfortable, optimising acoustic comfort must become a top priority for the industry.

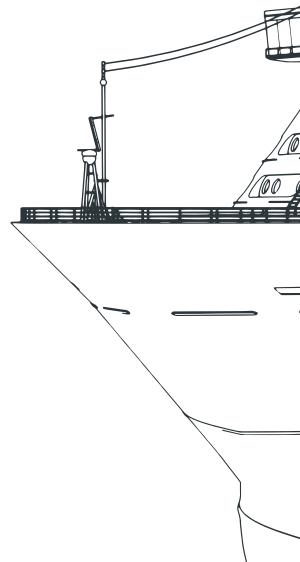



10-years warranty

Certified insulators can benefit from the ArmaFlex System Warranty if they install AF/ArmaFlex Evo, AF/ArmaFlex or ArmaFlex Ultima as a system with ArmaFix AF or ArmaFix Ultima.

AF/ArmaFlex Evo



Our AF/ArmaFlex products have a completely closed-cell material structure. The vapour barrier is not restricted to a thin foil but built up – cell by cell – throughout the entire insulation thickness. The highly flexible material increases the energy efficiency of the equipment, prevents condensation, supports corrosion protection and ensures that required line temperatures are maintained. The materials are flexible and easy to install, even when installations offer limited space on board.



ArmaFix®

The ArmaFix pipe support provides maximum reliability. It thermally isolates the pipe from the bracket and prevents thermal bridges. The system solution is coordinated with the respective insulation range and can be installed more quickly, neatly and easily than standard clamps. Our pipe support consists of pressure-resistant PET load-bearing segments which are embedded in the closed-cell insulation material.

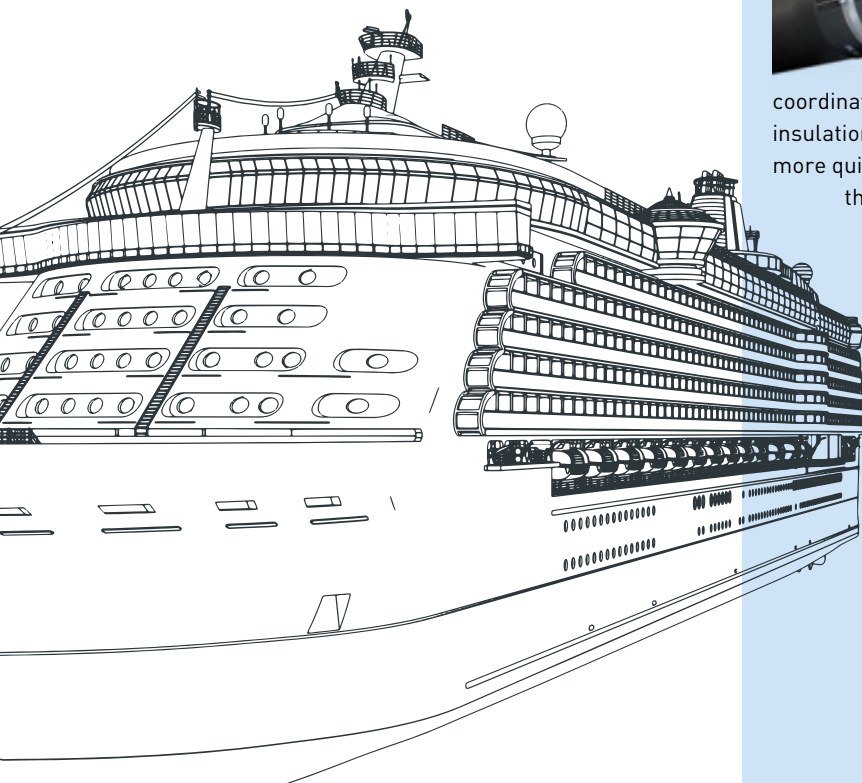
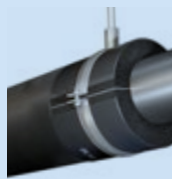

PRODUCT SPOTLIGHT

A large cruise ship hull is under construction in a massive industrial shipyard. The hull is white with a red and black stripe. The shipyard has a high ceiling with blue steel beams and skylights. The ship is positioned on a concrete pier with various industrial equipment and structures visible in the background.

ICONIC CRUISE SHIPS

Over the years, the Meyer Werft in Papenburg, Germany, has built around 50 luxury liners for discerning customers all over the world. When it comes to the insulation of chilled water and refrigeration pipes, the shipyard trusts Armacell products.

AF/ArmaFlex and ArmaFix AF pipe supports reliably prevent condensation and energy losses. Beverage pipes are insulated with the pre-coated ArmaChek Juna and since 2022, Meyer Werft has relied on ArmaFlex Protect as a safe and easy-to-install firestop solution for pipe penetrations.



FIRE PROTECTION

FIRE SAFETY ON PASSENGER FERRIES

The global ferry industry is similar in size to the commercial aviation industry, handling approximately 4.27 billion passengers and 373 million vehicles annually. Like the shipping industry in general, it is regulated in terms of safety, environmental impact and security by the International Maritime Organization (IMO).

A fire is one of the most dangerous things that can happen at sea. Roll-on/roll-off ferries are particularly vulnerable because of the cargo they carry - cars, trucks and refrigerated containers all contain combustible material and pose

fire hazards. Therefore, when designing and constructing ferries, fire protection is a major priority. The purpose of structural or passive fire protection is to prevent the propagation of fire and smoke from one fire compartment to another and give

people time to escape. Since technical installations such as pipes penetrate these fire divisions (bulkheads and decks) and can form a path along which flames and smoke could spread, pipework has to be sealed off professionally.

AF/ArmaFlex Evo



Our latest AF/ArmaFlex technology (8th generation) combines excellent condensation control and energy efficiency with advanced fire safety.

ArmaFix



This system solution with a built-in vapour barrier prevents thermal bridging and reduces the risk of condensation and corrosion.

ArmaClad Arma-Chek Juna

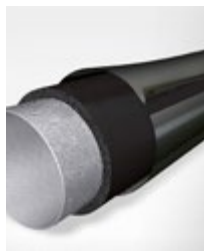

Whether protecting equipment exposed to mechanical stress or insulating python beverage lines, our pre-covered Arma-Chek Juna product provides a lightweight, easy-to-install solution.

ArmaGel



Our next-generation hydrophobic insulation material reduces the risk of corrosion under insulation (CUI) and can extend the service life of the equipment.

ArmaComfort Reflamex



Noise is an issue for both passengers and crew. Maximise the acoustic comfort on board with our ultra-thin, highly efficient sound barrier solution for the marine industry.

Navigate to the [product spotlights](#) by clicking on the image.

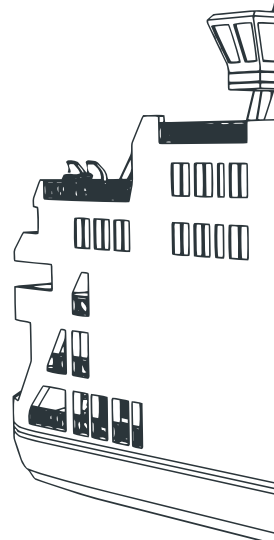



Fire safety

To enhance fire safety on board, we offer easy-to-install firestop solutions and insulation materials with an extremely low smoke density in the event of fire.

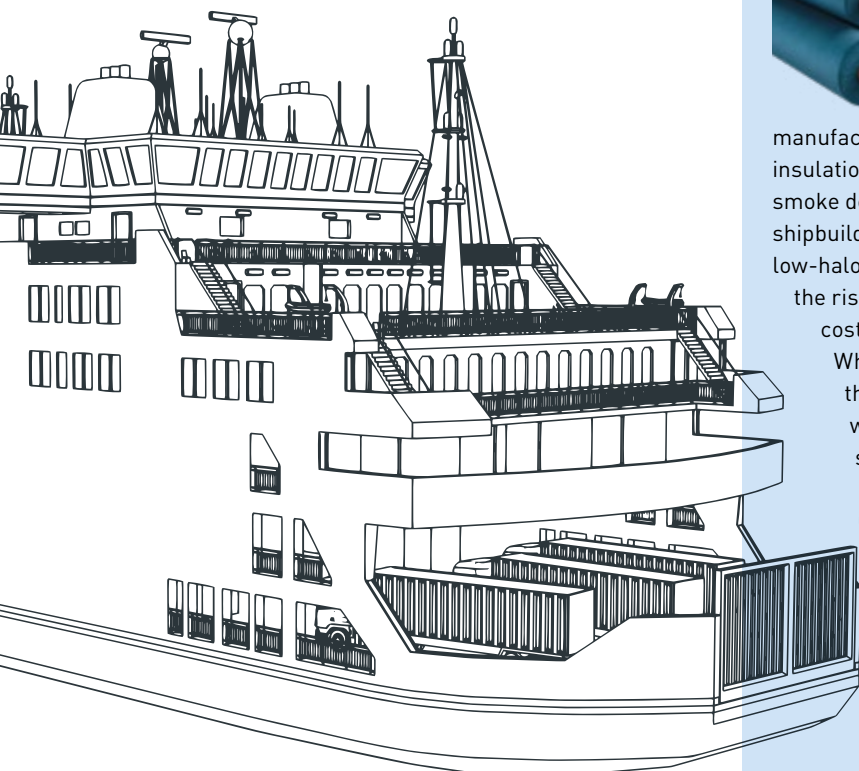

ArmaFlex Protect



To prevent flames and smoke from spreading in the event of fire, firestop penetrations through bulkheads and decks must be professionally sealed off. By combining the proven properties of ArmaFlex with an intumescent component, ArmaFlex Protect guarantees reliable fire safety in all A-class division and B-class bulkheads without the need for any complicated additional measures. At the same time, this product ensures effective thermal insulation and reliable condensation control.

ArmaFlex Ultima

In a fire, low smoke density can be of vital importance in ensuring that passengers



and employees can be rescued quickly and safely. With ArmaFlexUltima and ArmaFix Ultima, we are the first

manufacturer to offer flexible technical insulation materials with low smoke density in a fire for use in shipbuilding. What's more, the low-halogen material reduces the risk of consequential fire costs. It bears the European Wheelmark, which documents the product's conformity with the stringent standards set by the International Maritime Organization (IMO).



PRODUCT SPOTLIGHT



Safe travel by ferry

Fire safety must be a top priority and the IMO defined strict requirements for the fire behaviour, smoke development and toxicity of the materials and components used on board.

Our firestop solutions and low-smoke insulation materials contribute to a higher fire safety and can be installed on all types of vessels.



NOISE REDUCTION

ACOUSTIC COMFORT ON YACHTS

To ensure an unparalleled experience on board, modern yachts are equipped with all kinds of facilities and innovative technologies. For maximum cruising comfort, the various areas on a yacht must provide acoustic comfort and privacy.

Vessels have to cope with extreme noise levels that can go far beyond the most bustling street. The engine, bow thruster, electric generators, HVAC equipment and fittings, they all generate noise that spreads through the air and throughout the structure of the yacht. The hull and cabins are resonating bodies which can

amplify the noise. To combat the effects of noise and protect passengers from inconveniences onboard, partitioning the space with soundproofing materials is crucial. Our acoustic insulation materials block acoustic energy and prevent the propagation of noise. Installed on ceilings, floors or partitions, these

acoustic barriers offer excellent acoustic performance at minimal thickness and weight.

The noise from airducts and engines, on the other hand, must be minimised by sound absorbing materials with vibration damping properties.

ArmaFlex Ultima



Based on the patented ArmaPrene™ technology, our best-in-class solution mitigates fire and smoke risk and improves visibility and respiration in the event of a fire. As confirmed by Eurofins, the world market leader for product emission testing, ArmaFlex Ultima contributes to a healthy indoor air quality.

ArmaFlex Protect



In the event of a fire, our fire protection barrier expands and thus prevents the fire from spreading to adjacent building components.

ArmaClad Arma-Chek Juna

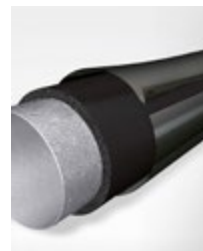

Easy-to-install pre-covered solution which allows the use of thinner insulation thickness due to its high thermal absorption.

ArmaPET® Struct



Based on 100 percent recycled PET, we offer a more sustainable composite solution that does not compromise on durability, weight and cost efficiency.

Navigate to the [product spotlights](#) by clicking on the image.

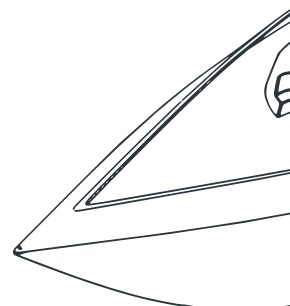



Acoustic comfort

is key to enhancing passenger experience and ensuring relaxation and well-being onboard.

ArmaComfort Reflamex



Our high-performance mass-loaded sound barrier guarantees a quieter environment on ships. It offers exceptional sound transmission loss properties across a broad frequency range with super-thin wall thicknesses and a high fire performance. Based on a unique EVA/EPM blend, this sound attenuation technology allows you to add mass to structural elements without losing space – invisibly in constructions or visibly on existing partition walls. ArmaComfort Reflamex is recyclable and free of halogens, fibres, phosphate, bitumen and lead.

ArmaSound® RD

This open-cell, fibre dust-free material ensures excellent sound absorption behaviour across the entire frequency range. The high-performance sound absorber also provides additional barrier (transmission loss) performance and both vibration damping and de-coupling (isolation) properties, making it the ideal choice for engine housings and ducting on small boats.



PRODUCT SPOTLIGHT

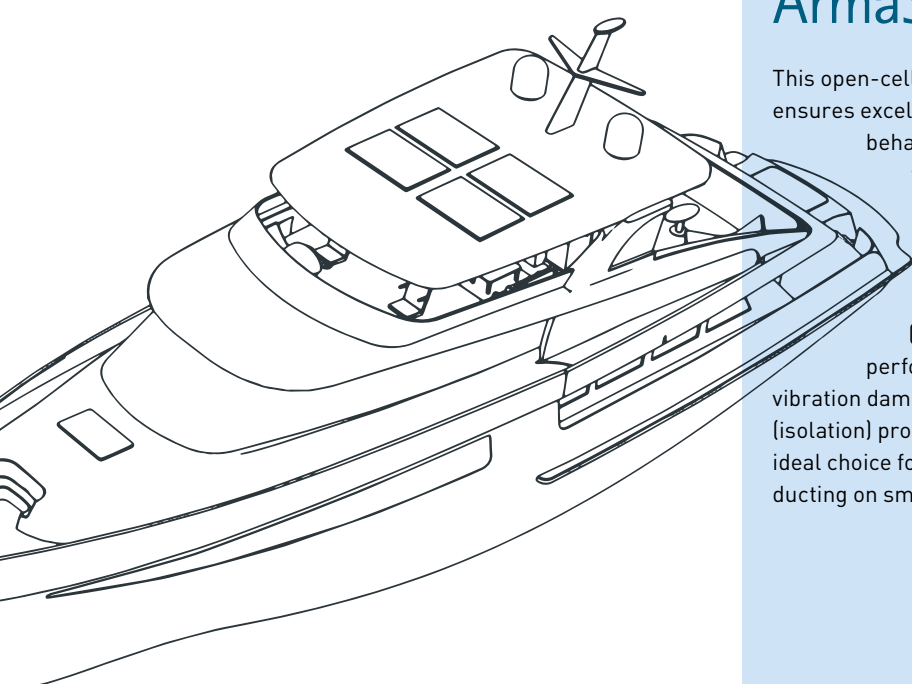



Luxury and leisure on superyachts

Poseidon Marine Air in Florida is just one of many installation companies worldwide which only trusts on Armacell's insulation solutions and accessories when they are contracted to insulate mechanical systems on superyachts.

"I will only use Armacell's products and have not considered using other materials," says Hector Castañeda, Owner and Installer at Poseidon Marine Air in Florida.



STRUCTURAL SANDWICH APPLICATIONS

LIGHTWEIGHT SOLUTIONS FOR SPORT BOATS

To meet the high requirements of the modern boatbuilding industry, it is essential to achieve high strength and durability in order to withstand rough sailing conditions, keep weight low, maximise performance, and build cost-efficiently. What's more, the demands on safety and sustainability for all watercrafts are constantly increasing.

Composites are cost-effective and can turn even high-end designs into reality. Core materials for sandwich structures must have special dynamic strength and stiffness and, of course, be resistant to water absorption. Our ArmaPET Struct products combine all of this, alongside with environmental considerations

and are constantly gaining ground on traditional materials like PVC, Balsa and SAN in today's boatbuilding industry.

They are the ideal choice for composite sandwich applications for hull, stringers and bulkheads, all located below the water line. These dynamically loaded

structures require stiff, strong and damage-tolerant cores, capable of absorbing high dynamic impacts such as slamming loads. Decks, superstructures, topsides and cabin interiors are located above the water line, where static properties are important.

AF/ArmaFlex Evo



Our lightweight classic insulation material has been installed on all type of boats for more than 40 years. The built-in Microban® antimicrobial technology provides proactive protection against bacteria, mould and mildew.

ArmaComfort Reflamex



State-of-the-art sound insulation which does not compromise the limited space onboard and ensures an effective reduction of airborne noise across a broad frequency range.

ArmaSound



Factors contributing to the sound pressure level on board are numerous with the engine being the most important source on motorised boats.

Navigate to the [product spotlights](#) by clicking on the image.

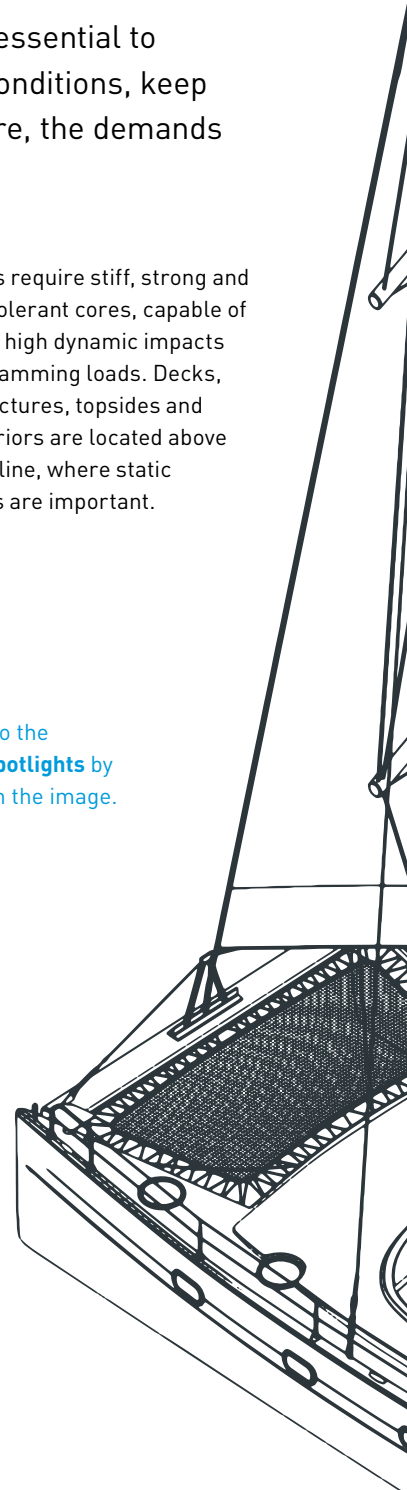



Composite solutions

Light weight, durability, sustainable materials and cost efficiency are key factors for maritime applications.

ArmaPET Struct



Our thermoplastic high-performance core foams provide a unique combination of material and processing properties, enhancing efficiency throughout the manufacturing process and elevating the life-cycle performance of composite structures.

The fatigue resistance easily meets the DNV requirements (threshold > 60 percent). ArmaPET Struct allows for high processing temperature up to +150 °C and can be processed with all common technologies such as infusion with full vacuum, pre-preg lamination processes and resin systems. It is thermoformable into 3D or double-curved sandwich panels, to name just a few.

Contributing to eco-friendly cruising

ArmaPET offers a more sustainable product solution. Based on 100 percent recycled material with full recyclability after service life, ArmaPET offers boat builders and operators a more sustainable product solution.

Its production requires less energy and generates fewer CO₂ emissions than conventional foam core materials.



PRODUCT SPOTLIGHT

fi

An aerial photograph of a boat on a vast expanse of deep blue water. The water's surface is covered in small, rhythmic waves. The boat, which appears to be a motorboat or speedboat, is visible in the lower right corner, moving towards the viewer and leaving a white wake behind it. The overall scene is serene and emphasizes the maritime environment.

At the core of light sport boats

Fast and sustainable boats can only be built with lightweight structural materials. While Balsa, SAN and PVC have been used for decades for composite structures, PET core foams are increasingly winning ground in

today's boatbuilding industry. And with good reason: they provide a unique combination of material and processing properties and, as a truly green product, enhance the life cycle performance of composite structures.



SAFEGUARD YOUR EQUIPMENT

MECHANICAL PROTECTION FOR MARINE REFRIGERATION

For the fishing industry, it is paramount that the catch stays fresh – all the way from the fishing ground to the consumer. To ensure that the cargo arrives in top condition, fishing vessels are equipped with refrigeration and freezing technologies that preserve the freshly caught fish at low temperatures on board.

As the generation of cold is very energy intensive, increasing the energy efficiency of refrigeration systems is crucial. Innovative cooling technologies based on waste heat recovery (WHR) from diesel engines are already used on board new commercial fishing vessels.

One of the easiest and cost-effective means to save energy, is to prevent energy losses of refrigeration equipment by closed-cell insulation. To protect the flexible insulation from mechanical impact, pre-covered elastomeric materials offer high mechanical resistance to damage.

Like most commercial vessels, the crew areas of trawlers and other larger fishing boats are nowadays equipped with HVAC for greater living comfort. To prevent condensation and energy losses, the cooling water pipes should be insulated with a closed-cell insulation material.

ArmaFlex Ultima



Thanks to its good thermal conductivity and high resistance to water vapour diffusion, the low-smoke ArmaFlex Ultima ensures reliable condensation control and high energy savings in the long term. This also minimises the risk of corrosion under insulation (CUI) and reduces the risk of costs associated with downtime. It can be used on cold service pipework for refrigeration systems everywhere onboard.

ArmaFix



Pipe hangers are typically potential weak spots in an insulation system. ArmaFix prevents thermal bridging and condensation, offering maximum reliability as well as quick and easy installation.

ArmaFlex Protect



Sealing off pipe penetrations couldn't be any easier: The tube is simply placed on the pipe and glued. A one-component, fast-curing, flame-retardant silicone sealant is used to close the annular gap.

[Navigate to the product spotlights by clicking on the image.](#)

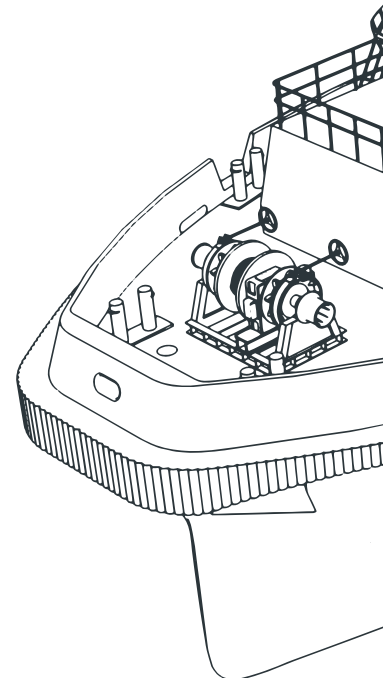



Reliable refrigeration

Energy-efficient refrigeration on board is essential and determines the length of time a fishing vessel can remain at sea.

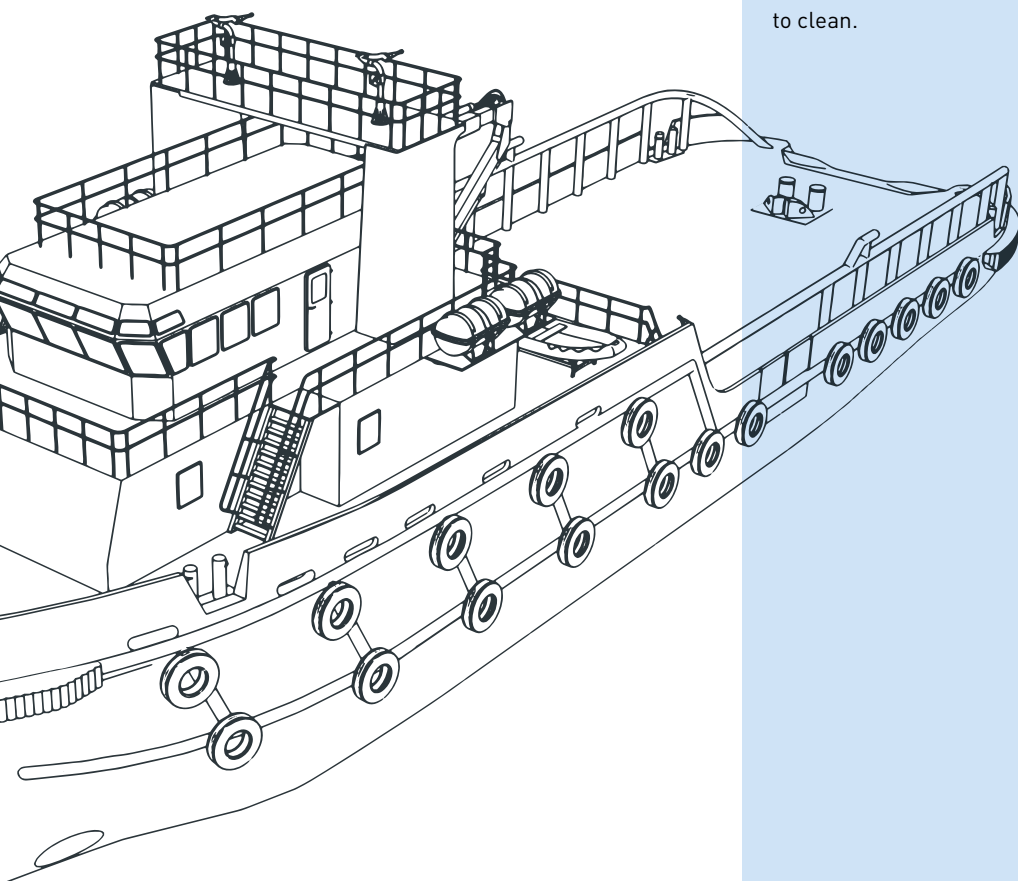

ArmaClad Arma-Chek Juna

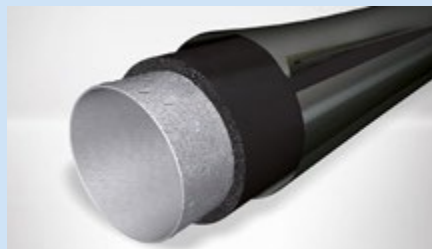

In areas subject to greater mechanical stress, technical insulation should be covered to protect it against damage. Flexible covering systems provide tough protection against weathering, mechanical impact and corrosion under insulation (CUI).

Our Arma-Chek Juna product has been specifically developed for marine applications. This pre-covered 2-in-1 solution can be installed in a single step and substantially reduces the fabrication and installation effort. The material is UV-resistant and thinner thicknesses can be specified thanks to the highly absorptive black surface. What's more, the robust surface is easy to clean.



PRODUCT
SPOTLIGHT

A photograph of a fishing boat on the ocean. The boat is white with a dark blue stripe and is partially visible on the right side. The sea is dark blue with white-capped waves. The sky is overcast and grey, filled with a large number of birds, likely terns, flying in various directions. The overall scene is one of a busy fishing operation in rough, open waters.

Fishing in rough waters

Whether on large vessels on international voyages or in smaller boats operating in domestic waters, fishing is an extremely tough job and insulation on fishing boats is exposed to high mechanical impact.

Our pre-covered Arma-Chek Juna product has been specifically developed for marine applications and provides mechanical protection on the high seas.



SPACE MATERIAL FOR MARINE APPLICATIONS

NEXT GENERATION INSULATION FOR CARGO SHIPS

Shipping is the least environmentally damaging mode of commercial transport. However, due to the enormous scale of the industry, it accounts for a significant proportion of the world's total greenhouse gas emissions and emits about 3 percent of total global CO₂ emissions.

The International Maritime Organization (IMO) aims to reduce the carbon intensity from international shipping as an average across international shipping by at least 40 percent by 2030, working towards 70 percent by 2050, compared to 2008 levels. To achieve these targets, the shipping industry is turning to alternative fuels such as LNG, LPG and hydrogen. The storage

and transport of these liquefied gases at cryogenic temperatures require highly effective insulation materials such as the aerogel-based ArmaGel.

Our latest innovation ArmaGel is considered one of the highest performing insulation materials available on the market today. Compared to conventional

insulation materials, ArmaGel has exceptionally low thermal conductivity and superior insulating properties, allowing the use of thinner insulation thicknesses. Our next-generation insulation material offers new solutions for innovative space-saving designs on board of all types of ships.

AF/ArmaFlex Evo



Thanks to the unrivalled combination of technical and installation features, AF/ArmaFlex offers superior performance at lower total installed cost. It is easy to install, even in extremely tight space on board.

ArmaFix



Our ArmaFix pipe support offers maximum reliability and can be installed easier, cleaner and faster than other pipe clamps. As the PET cores are made of recycled material, it also helps to conserve natural resources.

ArmaFlex Protect



This highly flexible firestop solution can be installed traditionally with or alternatively without steel sleeve.

ArmaClad Arma-Chek Juna

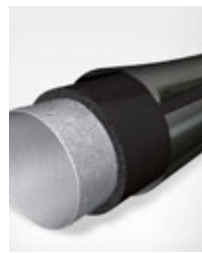

Our 2-in-1 system was specially developed for use in shipbuilding. It protects the surface of technical equipment that is not hidden behind walls, e.g., in engine rooms.

Navigate to the [product spotlights](#) by clicking on the image.

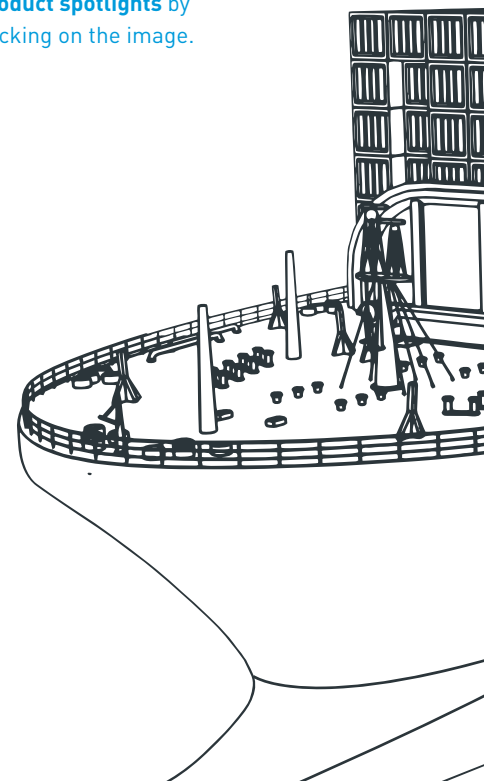

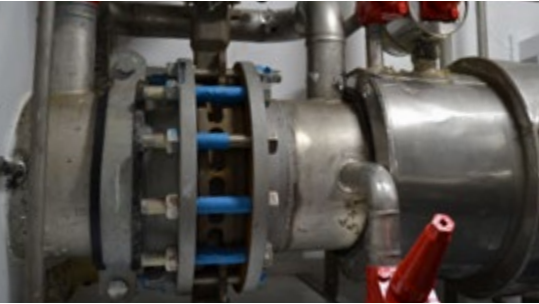

New superinsulation material

Used by NASA to bring home a piece of a comet because it's strong enough to stop a bullet in its tracks, aerogel offers an uncanny array of physical properties and incredible potential for insulation uses. It's the world's lightest and least dense solid material.

ArmaGel



Thanks to its exceptionally low thermal conductivity, ArmaGel is one of the best insulation materials available today. It is up to 80 percent thinner than conventional insulation and offers the same thermal insulation properties with only a fraction of the insulation thickness.

ArmaGel DT does not shrink at low temperatures and can be used on technical equipment with extremely low operating temperatures (down to -180°C). Plus, compared to conventional acoustic insulation systems, it delivers better acoustic insertion loss with less thickness and weight. The hydrophobic material reduces the risk of corrosion under insulation (CUI) and can thus extend the service life of the equipment.

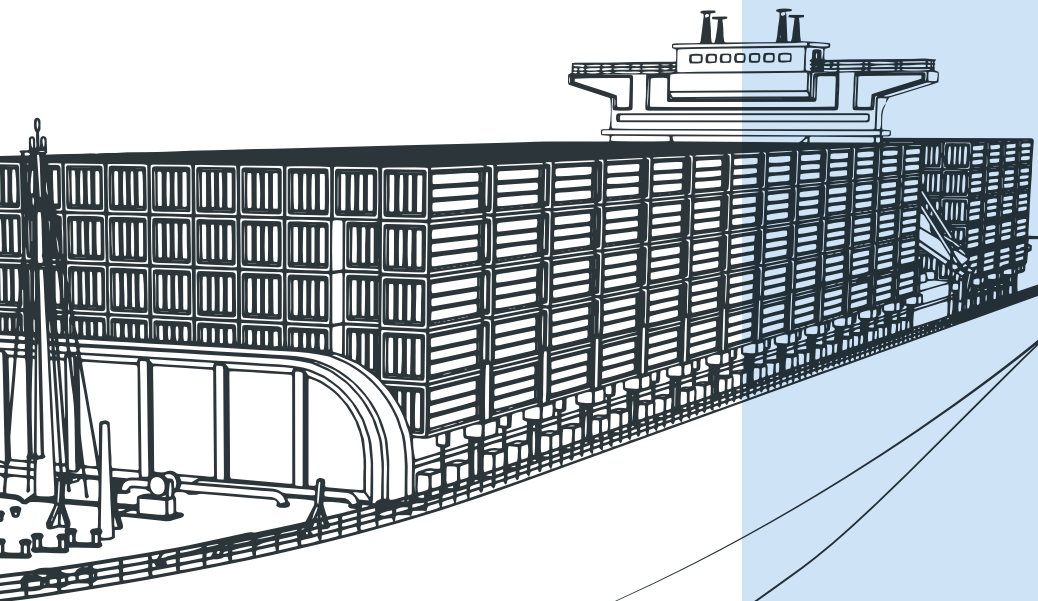

PRODUCT
SPOTLIGHT



New solutions for greener shipping

The shipping industry is responsible for the transport of 90 percent of all global trade. While conventional cargo ships use bunker fuel which is fractionally distilled from crude oil, shipping companies race to decarbonize their

supply chains and find alternatives to oil-powered container ships that account for an estimated 3 percent of global greenhouse gas emissions. Alternative liquefied gases require next-generation insulation technologies.



SHIPS ALREADY RELYING ON OUR SOLUTIONS

ALL OVER THE WORLD MAJOR SHIPPING COMPANIES HAVE SPECIFIED ARMACELL INSULATION MATERIALS FOR THEIR PROJECTS. HERE ARE JUST A FEW OF THE SUCCESSFUL PROJECTS REALISED:

// **All cruise ships (classes: Breakaway, Breakaway-Plus, Dawn, Jewel, Leo, Solstice, Dream, Radiance, Sphinx, Ikarus, Quantum, Evolution)**
built at the Meyer Werft, Papenburg (Germany)

// **Cruise ships of the Voyager, Oasis, Freedom, Spirit and Fantasy classes**
built at Kaverne Masa Yards, Helsinki, Turku (Finland)

// **Deep-sea research vessel Sonne**
(awarded the 'Blue Angel' eco-label), Meyer Werft, Papenburg (Germany)

// **Carnival Horizon**
Fincantieri, Marghera shipyard (Italy)

// **MSC Seaview**
Fincantieri, Monfalcone shipyard (Italy)

// **Queen Mary II**
Cruise ship, ALSTOM Chantiers de l'Atlantique, Saint-Nazaire (France)

// **MSC Divina**
STX France Cruise SA, Saint-Nazaire (France)

// **MS Plancius**
Converting a floating marine laboratory into a modern expedition vessel, Hansweert, Zeeland (Netherlands)

// **Royal Navy's Astute Class**
Nuclear-powered submarines (United Kingdom)

// **Royal Brunei Naval Ships**
(Kingdom of Brunei)

// **Beowulf**
Custom-designed Lavranos 43' sailboat, British Columbia (Canada)

// **T-AKE US**
Naval Cargo Ships, San Diego (USA)

// **Seahawk**
Trinity Yachts (USA)

// **ANZAC frigates**
HMAS Parramatta and other frigates for the Royal Australian Navy (Australia)

// **Indian Navy**
(India)

TRACK
RECORD

PRODUCT SELECTOR

	ArmaFlex Ultima	AF/ArmaFlex Evo	AF/ArmaFlex	ArmaFix	ArmaFlex Protect	ArmaClad Arma -Chek Juna	ArmaGel	ArmaComfort Reclamex	ArmaSound RD 240	ArmaPET Struct
CRUISE SHIPS	<input type="radio"/>	<input checked="" type="radio"/>	<input checked="" type="radio"/>	<input checked="" type="radio"/>	<input type="radio"/>	<input type="radio"/>	<input type="radio"/>	<input type="radio"/>	<input type="radio"/>	<input type="radio"/>
FERRIES	<input checked="" type="radio"/>	<input type="radio"/>	<input type="radio"/>	<input type="radio"/>	<input checked="" type="radio"/>	<input type="radio"/>	<input type="radio"/>	<input type="radio"/>	<input type="radio"/>	<input type="radio"/>
YACHTS	<input type="radio"/>	<input type="radio"/>	<input type="radio"/>	<input type="radio"/>	<input type="radio"/>	<input type="radio"/>	<input type="radio"/>	<input checked="" type="radio"/>	<input checked="" type="radio"/>	<input type="radio"/>
SPORT BOATS	<input type="radio"/>	<input type="radio"/>	<input type="radio"/>	<input type="radio"/>	<input type="radio"/>	<input type="radio"/>	<input type="radio"/>	<input type="radio"/>	<input type="radio"/>	<input checked="" type="radio"/>
FISHING VESSELS	<input type="radio"/>	<input type="radio"/>	<input type="radio"/>	<input type="radio"/>	<input type="radio"/>	<input checked="" type="radio"/>	<input type="radio"/>	<input type="radio"/>	<input type="radio"/>	<input type="radio"/>
CARGO SHIPS	<input type="radio"/>	<input type="radio"/>	<input type="radio"/>	<input type="radio"/>	<input type="radio"/>	<input type="radio"/>	<input checked="" type="radio"/>	<input type="radio"/>	<input type="radio"/>	<input type="radio"/>

Product spotlight

All data and technical information are based on results achieved under the specific conditions defined according to the testing standards referenced. Despite taking every precaution to ensure that said data and technical information are up to date, Armacell does not make any representation or warranty, express or implied, as to the accuracy, content or completeness of said data and technical information. Armacell also does not assume any liability towards any person resulting from the use of said data or technical information. Armacell reserves the right to revoke, modify or amend this document at any moment. It is the customer's responsibility to verify if the product is suitable for the intended application. The responsibility for professional and correct installation and compliance with relevant building regulations lies with the customer. This document does not constitute nor is part of a legal offer to sell or to contract.

At Armacell, your trust means everything to us, so we want to let you know your rights and make it easier for you to understand what information we collect and why we collect it. If you would like to find out about our processing of your data, please visit our [Data Protection Policy](#).

© Armacell, 2023. All brands followed by ® or ™ are trademarks of the Armacell Group.
Microban® is a trademark of Microban Products Company and is used herein with permission.
00XXX | Marine Solutions | Reference Brochure | 062023 | EMEA | EN

ABOUT ARMACELL

As the inventor of flexible foam for equipment insulation and a leading provider of engineered foams, Armacell develops innovative and safe thermal and mechanical solutions that create sustainable value for its customers. Armacell's products significantly contribute to global energy efficiency making a difference around the world every day. With more than 3,300 employees and 27 production plants in 19 countries, the company operates two main businesses, Advanced Insulation and Engineered Foams. Armacell focuses on insulation materials for technical equipment, high-performance foams for acoustic and lightweight applications, recycled PET products, next-generation aerogel technology and passive fire protection systems.

For further product information, please visit:
www.armacell.eu

 **armacell**[®]
MAKING A DIFFERENCE AROUND THE WORLD